

STANDARD 4" ROUND OR SQUARE PANCAKE BOX WITH HANGAR BAR. USE PROPER ANCHOR BOLTS/LAG BOLTS TO SECURE.

110/120 V RUN

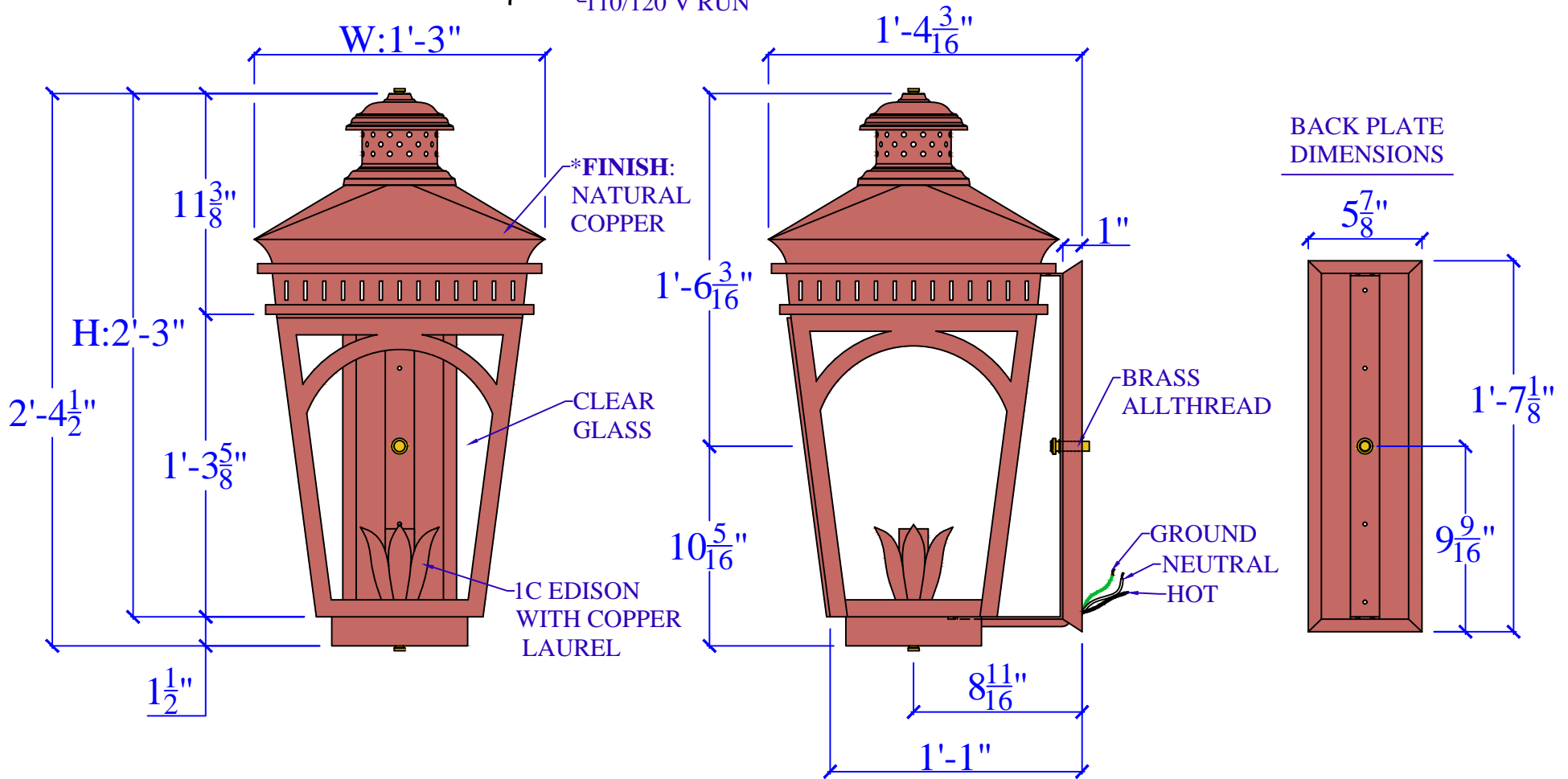

CAROLINA GAS LANTERNS

1800 EAST I-65 SERVICE RD. N. MOBILE, ALABAMA 36617 PHONE: (251) 478-0072
 WWW.CAROLINAGASLANTERNS.COM

SPECIFICATION SHEET

COPYRIGHT 1994 TO CURRENT YEAR, CAROLINA GAS LANTERNS (CGL)
 ALL DESIGNS, DRAWINGS, MODEL NUMBERS, AND LANTERN DESIGNATIONS ARE THE SOLE AND EXCLUSIVE PROPERTY OF (CGL) AND SHALL NOT BE DUPLICATED IN WHOLE OR PART WITHOUT THE WRITTEN CONSENT OF (CGL).

LIGHT:	THE STRICKLAND - H27" W15" - 1C	DATE:	APP.BY:	J.D.
BRACKET:	6C-C - CAROLINA GAS LANTERNS		REV.	