

STANDARD 4" ROUND OR SQUARE PANCAKE BOX WITH HANGAR BAR. USE PROPER ANCHOR BOLTS/LAG BOLTS TO SECURE.

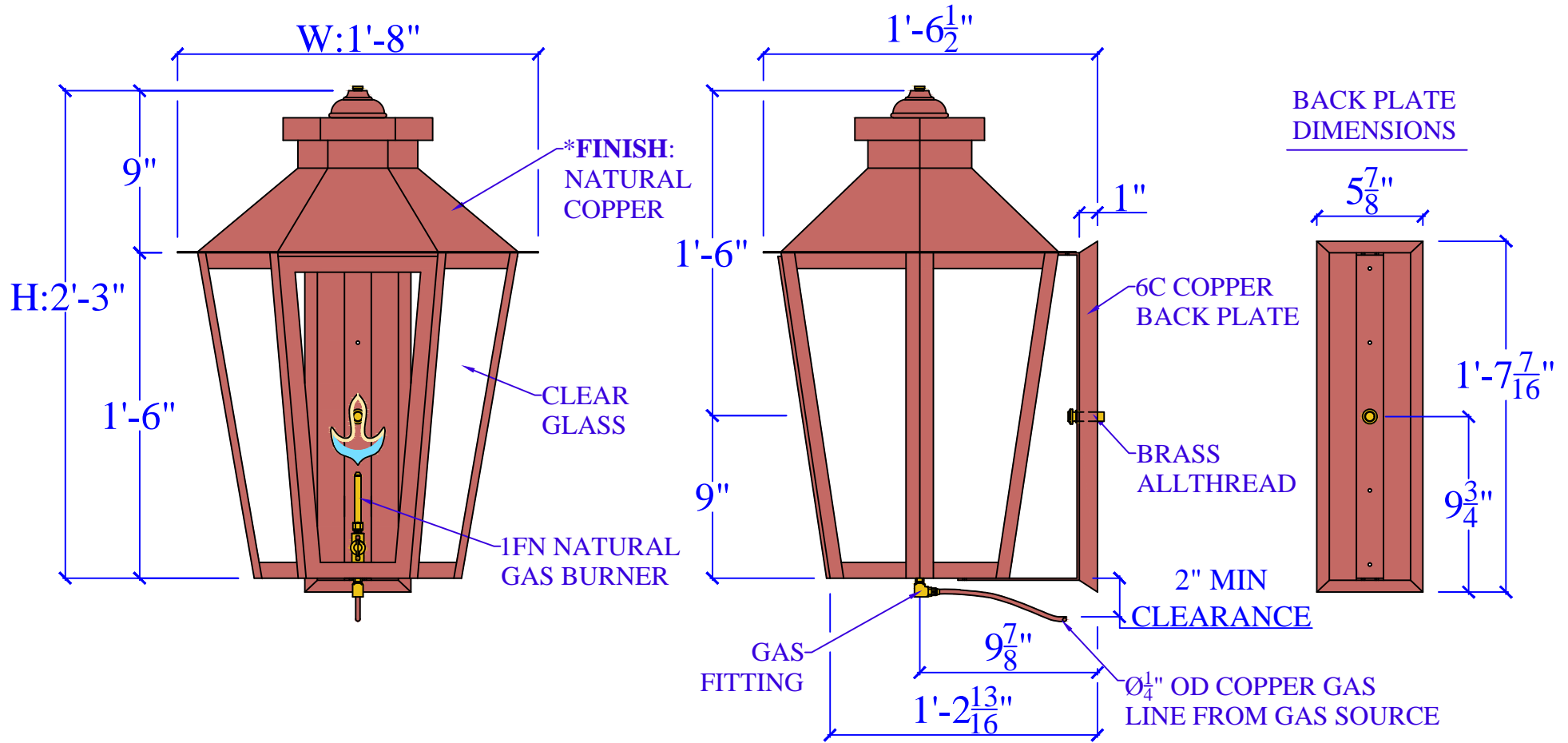

**CAROLINA GAS LANTERNS**

1800 EAST I-65 SERVICE RD. N. MOBILE, ALABAMA 36617 PHONE: (251) 478-0072  
 WWW.CAROLINAGASLANTERNS.COM

**SPECIFICATION SHEET**

COPYRIGHT 1994 TO CURRENT YEAR, CAROLINA GAS LANTERNS (CGL)  
 ALL DESIGNS, DRAWINGS, MODEL NUMBERS, AND LANTERN DESIGNATIONS ARE THE SOLE AND EXCLUSIVE PROPERTY OF (CGL) AND SHALL NOT BE DUPLICATED IN WHOLE OR PART WITHOUT THE WRITTEN CONSENT OF (CGL).

LIGHT:	THE ORLEANS - H27" W20" - 1FN	DATE:	APP.BY:	J.D.
BRACKET:	6C-C - CAROLINA GAS LANTERNS	REV.		