

STANDARD 4" ROUND OR SQUARE PANCAKE BOX WITH HANGAR BAR. USE PROPER ANCHOR BOLTS/LAG BOLTS TO SECURE.

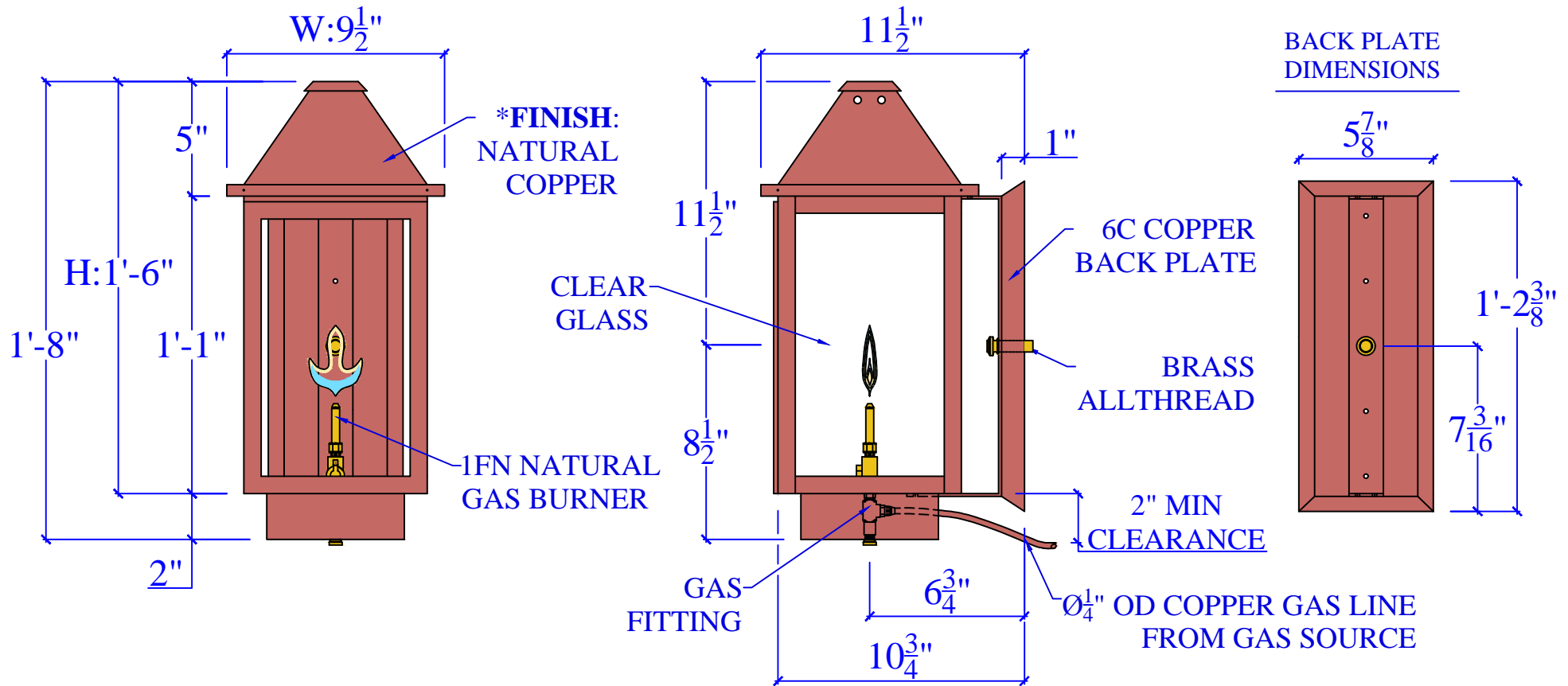

CAROLINA GAS LANTERNS

1800 EAST I-65 SERVICE RD. N. PHONE: (251) 478-0072 FAX: (251) 471-5945 MOBILE, ALABAMA 36617
 WWW.CHARLESTONLIGHTING.COM WWW.FAUBOURGLIGHTING.COM WWW.CHARLESTONGASLIGHT.COM

SPECIFICATION SHEET

COPYRIGHT 1994 TO CURRENT YEAR, JOHNSTONE BAY, INC. (JB) ALL DESIGNS, DRAWINGS, MODEL NUMBERS, AND LANTERN DESIGNATIONS ARE THE SOLE AND EXCLUSIVE PROPERTY OF (JB) AND SHALL NOT BE DUPLICATED IN WHOLE OR PART WITHOUT THE WRITTEN CONSENT OF (JB).

LIGHT:	THE STANDARD - H18" W9 $\frac{1}{2}$ " - 1FN	DATE:	APP.BY:	J.D.
BRACKET:	6C-C - CAROLINA GAS LANTERNS		REV.	